









Micky

IP65 Twin Spot Emergency Light



-  IP65
-  IK08 RATED
-  Emergency
-  50,000 Hours
-  LITHIUM BATTERY
3HR DISCHARGE
-  SAA
-  >80
-  3YR WARRANTY

FEATURES

- Low power consumption
- Wall mount
- Easy testing and maintenance
- Non-maintained
- 3 hour discharge
- Designed and manufactured to AS/NZS2293.3
- Polycarbonate body

DIMENSIONS

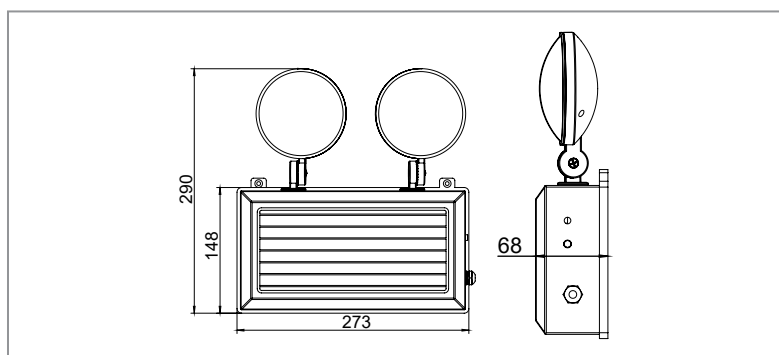

SPECIFICATIONS

Order Code	E1704
Model Number	LWME1704
Input Voltage	240v
Wattage	2 x 3w
Construction	Polycarbonate body
Mounting	Wall mounting
Beam Angle	120°
Operating Mode	Non Maintained
Testing System	Manual
Battery	Lithium 1800mAh 3 hour discharge
AS2293 Classification	C0=D40 C90=D40
Applicable Standard	AS/NZS2293.3
Operating Temp	1°C to 40°C
Battery	3 hour discharge
Dimensions (mm)	290x273x68
Weight	0.92kg