

Indoor Luminaire Photometric Data

Description Information

Luminary Name: 20W 4000K		Lum. Catalog:	Test ID: 001
Lamp Name:		Lamp Catalog: LED	Test Date: 2019/04/12
Manufacture:		Shld. Ang(°):	Test Machine:GON-2000
Test Lab: Volnic IES	Frequency (Hz):		Lamp CCT (K): Ra:
Lum. Size (W*L*H): 0.075m*1.200m*0.000m		Lum. Area (m2): 0.090	Lum. W (kg): 0.500
Test System: C, γ	Test Step: C=30.0 γ=1.0	Temp. (°C): 25	Humidity (%): 50.0

Character Parameter

Lamp Speciality Parameter		Luminaire Speciality Parameter	
Rated Flux (lm): 1801.870	Luminary Flux (lm): 1801.873	Field Angle (10%Imax): 201.0(°)	
Rated Power (W):	Luminary Efficiency: 100.00%	Down Lumens&Percent: 1678.338lm 93.14%	
Rated Voltage (V):	Luminary EER (lm/W): 94.736	Up Lumens&Percent: 123.536lm 6.86%	
Tested Power (W): 19.020	Max. Candela (cd): 533.491	S/MH: C0_a180=1.278 C90_270=1.272	
Lamps' Inside: 1	Max Cand@Ang. (°): C=0.0 γ=1.0	CIE Type: Semi-Direct	
Tested Electrics (V, A, pf): 240.0, 0.094, 0.837	Beam Angle (50%Imax): 119.4(°)	ErP Φ use (120°): 1225.471lm	
Lamp Size (W*L*H): 0.075m*1.200m*0.000m	Left=-58.9°, Right=60.4°	IRF (%): 106.678	

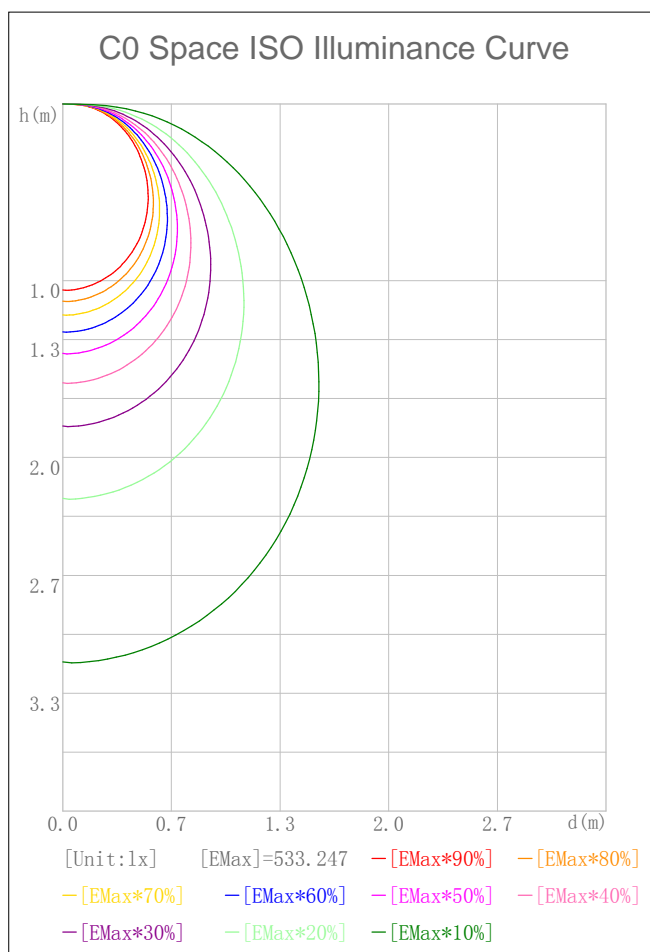
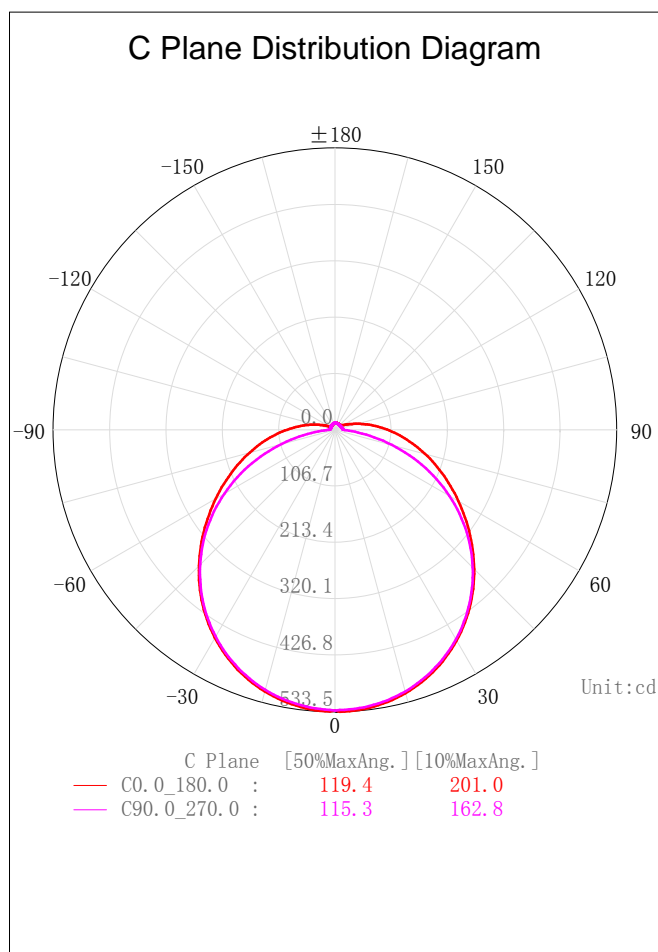

2D Plane Light Intensity Distribution Curve

Lum. Name: 20W 4000K	Lum. Catalog:	Test ID: 001
Lamp Name:	Lamp Catalog: LED	Test Lab: Volnic IES
Manufacture:	Test Machine:GON-2000	Test Date: 2019/04/12

C Plane Distribution Diagram

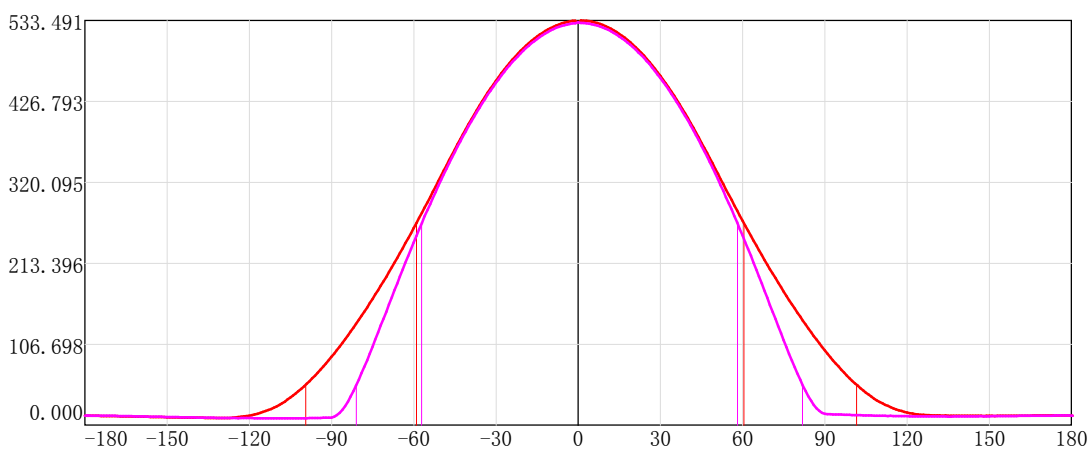
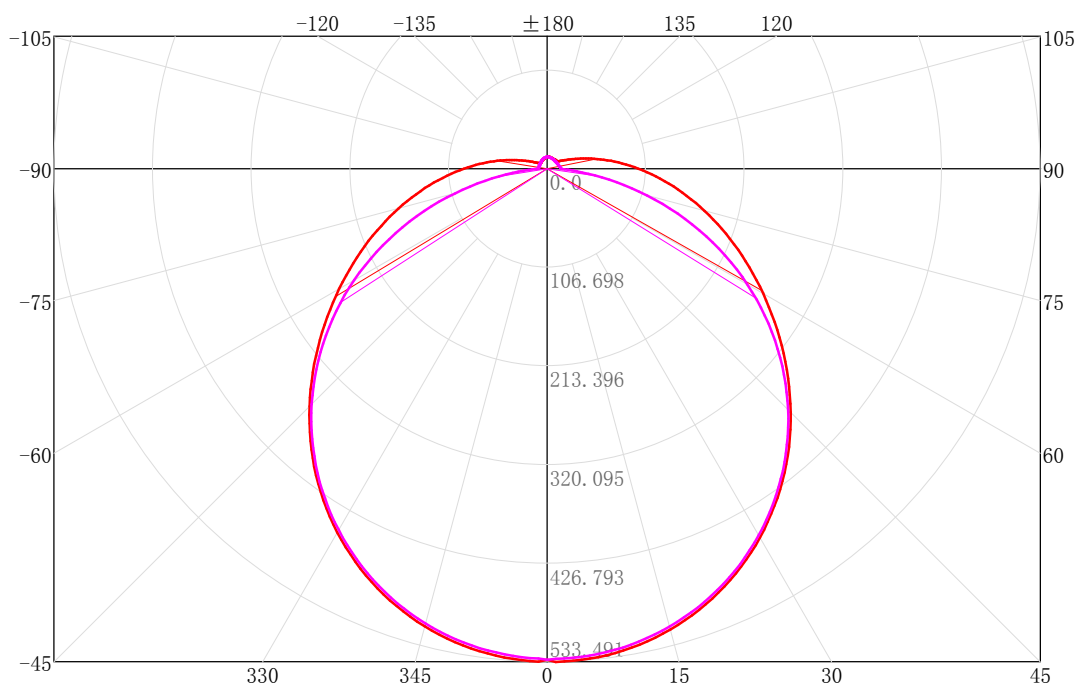

—	C Plane	[50%MaxAng.]	[10%MaxAng.]	Unit:cd
—	C0_0_180.0 :	119.4	201.0	
—	C90_0_270.0 :	115.3	162.8	

3D Light Intensity Distribution Modal

Lum. Name: 20W 4000K	Lum. Catalog:	Test ID: 001
Lamp Name:	Lamp Catalog: LED	Test Lab: Volnic IES
Manufacture:	Test Machine:GON-2000	Test Date: 2019/04/12

3D Light Intensity Distribution Modal

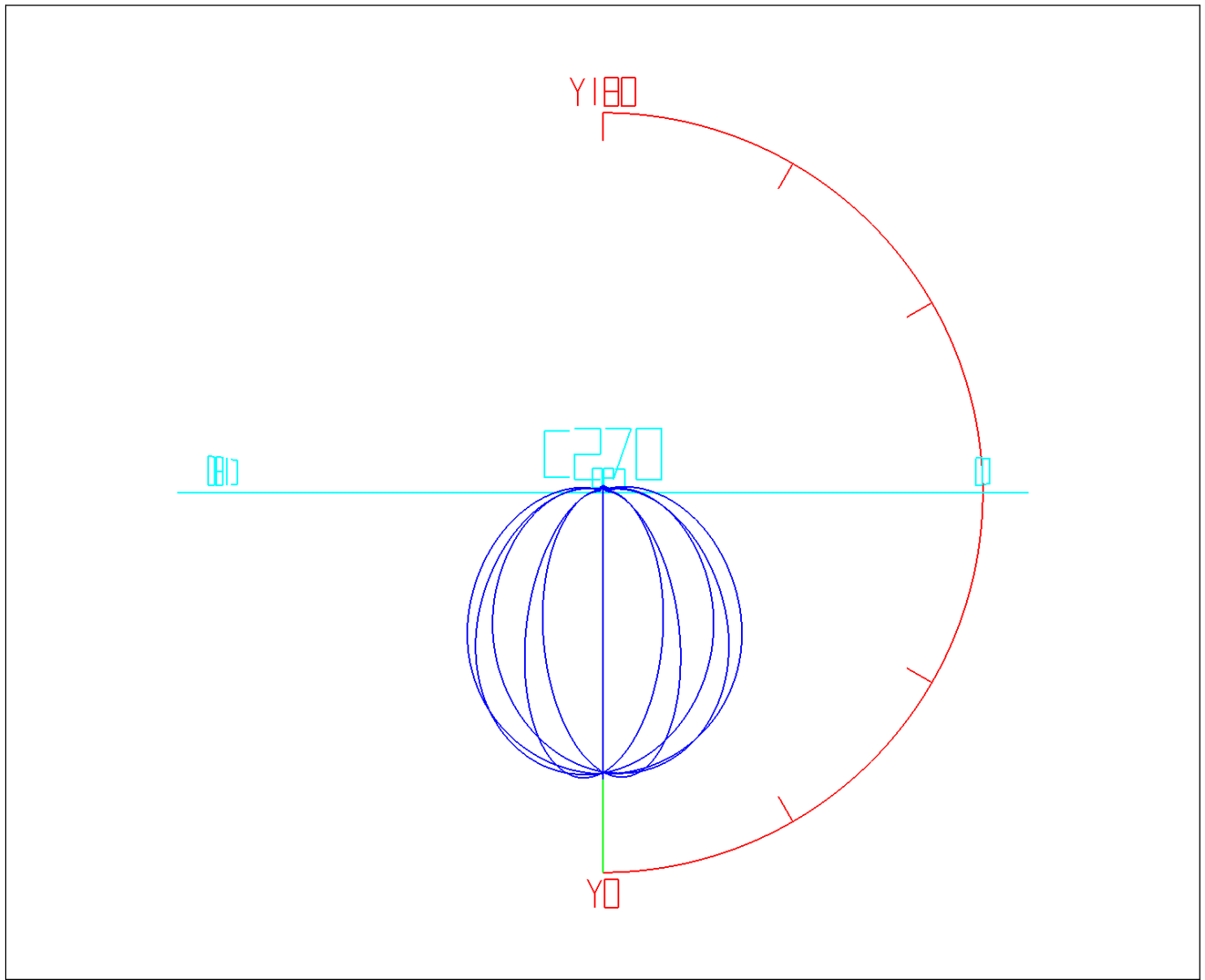

Curves: 3D Model ——— Fixture ——— Vert. HUD ——— Hori. HUD ———
View Angles: Orient:0 Tilt:0 Roll:0 Spin:0

IES Indoor Report
Photometric Filename:20W 4000K.IES

Zonal Flux Tabulation

Zone (γ)	Zone Flux (lm)	Sums Flux (lm)	Zone%Lamp	Sums%Lamp	Zone (γ)	Zone Flux (lm)	Sums Flux (lm)	Zone%Lamp	Sums%Lamp
0.0-1.0	0.51	0.51	0.03	0.03	47.0-48.0	28.11	909.04	1.56	50.45
1.0-2.0	1.52	2.03	0.08	0.11	48.0-49.0	27.96	937.00	1.55	52.00
2.0-3.0	2.54	4.57	0.14	0.25	49.0-50.0	27.79	964.79	1.54	53.54
3.0-4.0	3.55	8.11	0.20	0.45	50.0-51.0	27.57	992.36	1.53	55.07
4.0-5.0	4.55	12.67	0.25	0.70	51.0-52.0	27.32	1019.68	1.52	56.59
5.0-6.0	5.55	18.22	0.31	1.01	52.0-53.0	27.04	1046.72	1.50	58.09
6.0-7.0	6.54	24.76	0.36	1.37	53.0-54.0	26.73	1073.46	1.48	59.57
7.0-8.0	7.53	32.29	0.42	1.79	54.0-55.0	26.40	1099.85	1.46	61.04
8.0-9.0	8.50	40.79	0.47	2.26	55.0-56.0	26.03	1125.88	1.44	62.48
9.0-10.0	9.47	50.26	0.53	2.79	56.0-57.0	25.64	1151.52	1.42	63.91
10.0-11.0	10.42	60.67	0.58	3.37	57.0-58.0	25.21	1176.73	1.40	65.31
11.0-12.0	11.36	72.03	0.63	4.00	58.0-59.0	24.76	1201.50	1.37	66.68
12.0-13.0	12.28	84.31	0.68	4.68	59.0-60.0	24.30	1225.79	1.35	68.03
13.0-14.0	13.19	97.50	0.73	5.41	60.0-61.0	23.81	1249.60	1.32	69.35
14.0-15.0	14.08	111.57	0.78	6.19	61.0-62.0	23.30	1272.90	1.29	70.64
15.0-16.0	14.95	126.53	0.83	7.02	62.0-63.0	22.76	1295.66	1.26	71.91
16.0-17.0	15.81	142.33	0.88	7.90	63.0-64.0	22.20	1317.86	1.23	73.14
17.0-18.0	16.64	158.97	0.92	8.82	64.0-65.0	21.63	1339.49	1.20	74.34
18.0-19.0	17.45	176.42	0.97	9.79	65.0-66.0	21.04	1360.54	1.17	75.51
19.0-20.0	18.24	194.66	1.01	10.80	66.0-67.0	20.45	1380.98	1.13	76.64
20.0-21.0	19.01	213.67	1.05	11.86	67.0-68.0	19.84	1400.82	1.10	77.74
21.0-22.0	19.75	233.42	1.10	12.95	68.0-69.0	19.21	1420.03	1.07	78.81
22.0-23.0	20.47	253.89	1.14	14.09	69.0-70.0	18.57	1438.61	1.03	79.84
23.0-24.0	21.16	275.05	1.17	15.26	70.0-71.0	17.93	1456.54	1.00	80.83
24.0-25.0	21.82	296.87	1.21	16.48	71.0-72.0	17.29	1473.82	0.96	81.79
25.0-26.0	22.46	319.33	1.25	17.72	72.0-73.0	16.64	1490.46	0.92	82.72
26.0-27.0	23.06	342.39	1.28	19.00	73.0-74.0	15.99	1506.44	0.89	83.60
27.0-28.0	23.64	366.03	1.31	20.31	74.0-75.0	15.33	1521.78	0.85	84.46
28.0-29.0	24.18	390.22	1.34	21.66	75.0-76.0	14.67	1536.45	0.81	85.27
29.0-30.0	24.70	414.92	1.37	23.03	76.0-77.0	14.02	1550.47	0.78	86.05
30.0-31.0	25.19	440.10	1.40	24.42	77.0-78.0	13.38	1563.85	0.74	86.79
31.0-32.0	25.64	465.74	1.42	25.85	78.0-79.0	12.74	1576.59	0.71	87.50
32.0-33.0	26.05	491.79	1.45	27.29	79.0-80.0	12.11	1588.70	0.67	88.17
33.0-34.0	26.44	518.23	1.47	28.76	80.0-81.0	11.49	1600.19	0.64	88.81
34.0-35.0	26.79	545.02	1.49	30.25	81.0-82.0	10.88	1611.06	0.60	89.41
35.0-36.0	27.10	572.12	1.50	31.75	82.0-83.0	10.28	1621.34	0.57	89.98
36.0-37.0	27.39	599.51	1.52	33.27	83.0-84.0	9.70	1631.04	0.54	90.52
37.0-38.0	27.63	627.14	1.53	34.80	84.0-85.0	9.14	1640.18	0.51	91.03
38.0-39.0	27.84	654.98	1.55	36.35	85.0-86.0	8.60	1648.78	0.48	91.50
39.0-40.0	28.01	682.99	1.55	37.90	86.0-87.0	8.09	1656.87	0.45	91.95
40.0-41.0	28.15	711.14	1.56	39.47	87.0-88.0	7.60	1664.47	0.42	92.37
41.0-42.0	28.25	739.40	1.57	41.03	88.0-89.0	7.15	1671.62	0.40	92.77
42.0-43.0	28.32	767.72	1.57	42.61	89.0-90.0	6.72	1678.34	0.37	93.14
43.0-44.0	28.35	796.07	1.57	44.18	90.0-91.0	6.33	1684.67	0.35	93.50
44.0-45.0	28.34	824.41	1.57	45.75	91.0-92.0	5.96	1690.63	0.33	93.83
45.0-46.0	28.30	852.71	1.57	47.32	92.0-93.0	5.60	1696.23	0.31	94.14
46.0-47.0	28.22	880.93	1.57	48.89	93.0-94.0	5.26	1701.49	0.29	94.43

IES Indoor Report
Photometric Filename:20W 4000K.IES

Zonal Flux Tabulation - (Cont.)

Zone (γ)	Zone Flux (lm)	Sums Flux (lm)	Zone%Lamp	Sums%Lamp	Zone (γ)	Zone Flux (lm)	Sums Flux (lm)	Zone%Lamp	Sums%Lamp
94.0-95.0	4.93	1706.42	0.27	94.70	141.0-142.0	0.77	1786.04	0.04	99.12
95.0-96.0	4.62	1711.03	0.26	94.96	142.0-143.0	0.75	1786.80	0.04	99.16
96.0-97.0	4.33	1715.36	0.24	95.20	143.0-144.0	0.74	1787.54	0.04	99.20
97.0-98.0	4.05	1719.41	0.22	95.42	144.0-145.0	0.72	1788.26	0.04	99.24
98.0-99.0	3.79	1723.20	0.21	95.63	145.0-146.0	0.71	1788.97	0.04	99.28
99.0-100.0	3.54	1726.73	0.20	95.83	146.0-147.0	0.70	1789.67	0.04	99.32
100.0-101.0	3.31	1730.04	0.18	96.01	147.0-148.0	0.68	1790.35	0.04	99.36
101.0-102.0	3.09	1733.14	0.17	96.19	148.0-149.0	0.66	1791.01	0.04	99.40
102.0-103.0	2.89	1736.03	0.16	96.35	149.0-150.0	0.65	1791.66	0.04	99.43
103.0-104.0	2.71	1738.74	0.15	96.50	150.0-151.0	0.63	1792.29	0.03	99.47
104.0-105.0	2.53	1741.27	0.14	96.64	151.0-152.0	0.61	1792.90	0.03	99.50
105.0-106.0	2.36	1743.63	0.13	96.77	152.0-153.0	0.59	1793.49	0.03	99.54
106.0-107.0	2.20	1745.83	0.12	96.89	153.0-154.0	0.58	1794.07	0.03	99.57
107.0-108.0	2.06	1747.89	0.11	97.00	154.0-155.0	0.56	1794.63	0.03	99.60
108.0-109.0	1.93	1749.82	0.11	97.11	155.0-156.0	0.54	1795.17	0.03	99.63
109.0-110.0	1.83	1751.65	0.10	97.21	156.0-157.0	0.52	1795.69	0.03	99.66
110.0-111.0	1.73	1753.38	0.10	97.31	157.0-158.0	0.50	1796.20	0.03	99.69
111.0-112.0	1.64	1755.02	0.09	97.40	158.0-159.0	0.49	1796.68	0.03	99.71
112.0-113.0	1.56	1756.58	0.09	97.49	159.0-160.0	0.47	1797.15	0.03	99.74
113.0-114.0	1.48	1758.06	0.08	97.57	160.0-161.0	0.45	1797.59	0.02	99.76
114.0-115.0	1.41	1759.47	0.08	97.65	161.0-162.0	0.43	1798.02	0.02	99.79
115.0-116.0	1.35	1760.83	0.08	97.72	162.0-163.0	0.41	1798.42	0.02	99.81
116.0-117.0	1.30	1762.12	0.07	97.79	163.0-164.0	0.38	1798.81	0.02	99.83
117.0-118.0	1.25	1763.37	0.07	97.86	164.0-165.0	0.36	1799.17	0.02	99.85
118.0-119.0	1.20	1764.58	0.07	97.93	165.0-166.0	0.34	1799.51	0.02	99.87
119.0-120.0	1.17	1765.74	0.06	98.00	166.0-167.0	0.32	1799.83	0.02	99.89
120.0-121.0	1.13	1766.87	0.06	98.06	167.0-168.0	0.30	1800.13	0.02	99.90
121.0-122.0	1.10	1767.97	0.06	98.12	168.0-169.0	0.28	1800.41	0.02	99.92
122.0-123.0	1.07	1769.04	0.06	98.18	169.0-170.0	0.25	1800.66	0.01	99.93
123.0-124.0	1.04	1770.08	0.06	98.24	170.0-171.0	0.23	1800.89	0.01	99.95
124.0-125.0	1.02	1771.09	0.06	98.29	171.0-172.0	0.21	1801.09	0.01	99.96
125.0-126.0	1.00	1772.09	0.06	98.35	172.0-173.0	0.18	1801.27	0.01	99.97
126.0-127.0	0.98	1773.06	0.05	98.40	173.0-174.0	0.16	1801.43	0.01	99.98
127.0-128.0	0.96	1774.03	0.05	98.45	174.0-175.0	0.13	1801.57	0.01	99.98
128.0-129.0	0.95	1774.97	0.05	98.51	175.0-176.0	0.11	1801.68	0.01	99.99
129.0-130.0	0.93	1775.91	0.05	98.56	176.0-177.0	0.09	1801.76	0.00	99.99
130.0-131.0	0.92	1776.83	0.05	98.61	177.0-178.0	0.06	1801.82	0.00	100.00
131.0-132.0	0.91	1777.73	0.05	98.66	178.0-179.0	0.04	1801.86	0.00	100.00
132.0-133.0	0.89	1778.63	0.05	98.71	179.0-180.0	0.01	1801.87	0.00	100.00
133.0-134.0	0.88	1779.51	0.05	98.76					
134.0-135.0	0.87	1780.37	0.05	98.81					
135.0-136.0	0.85	1781.22	0.05	98.85					
136.0-137.0	0.84	1782.06	0.05	98.90					
137.0-138.0	0.83	1782.88	0.05	98.95					
138.0-139.0	0.81	1783.69	0.05	98.99					
139.0-140.0	0.80	1784.49	0.04	99.04					
140.0-141.0	0.78	1785.27	0.04	99.08					

Rectangle ISO Lighting Intensity Diagram

Lum. Name: 20W 4000K	Lum. Catalog:	Test ID: 001
Lamp Name:	Lamp Catalog: LED	Test Lab: Volnic IES
Manufacture:	Test Machine:GON-2000	Test Date: 2019/04/12

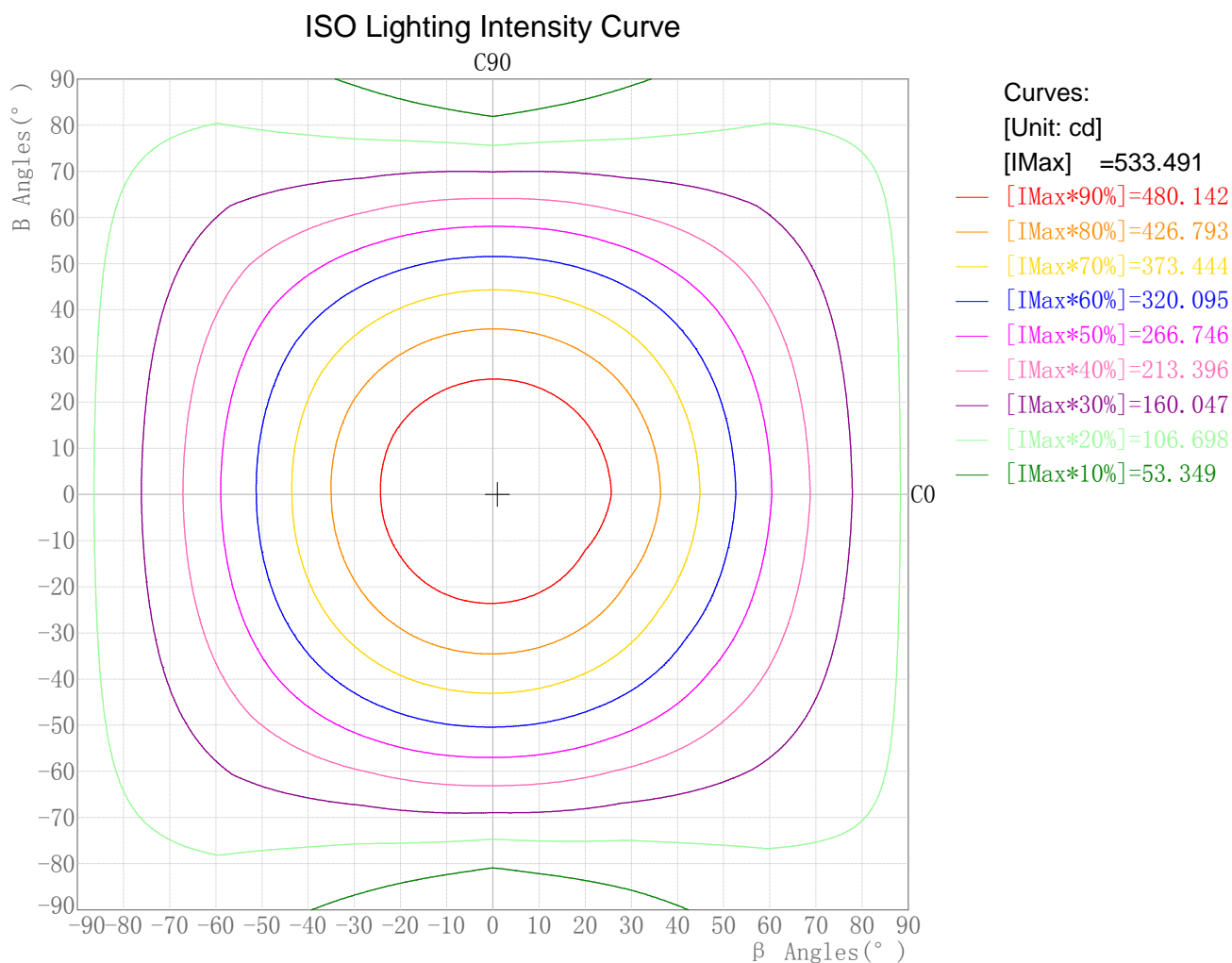

Maximum Light Intensity(cd): 533.49
Maximum Cand.@Angle: H=1.0°;V=0.0°

Plane ISO-Illuminance Diagram

Lum. Name: 20W 4000K	Lum. Catalog:	Test ID: 001
Lamp Name:	Lamp Catalog: LED	Test Lab: Volnic IES
Manufacture:	Test Machine:GON-2000	Test Date: 2019/04/12

Plane ISO-Illuminance Curve

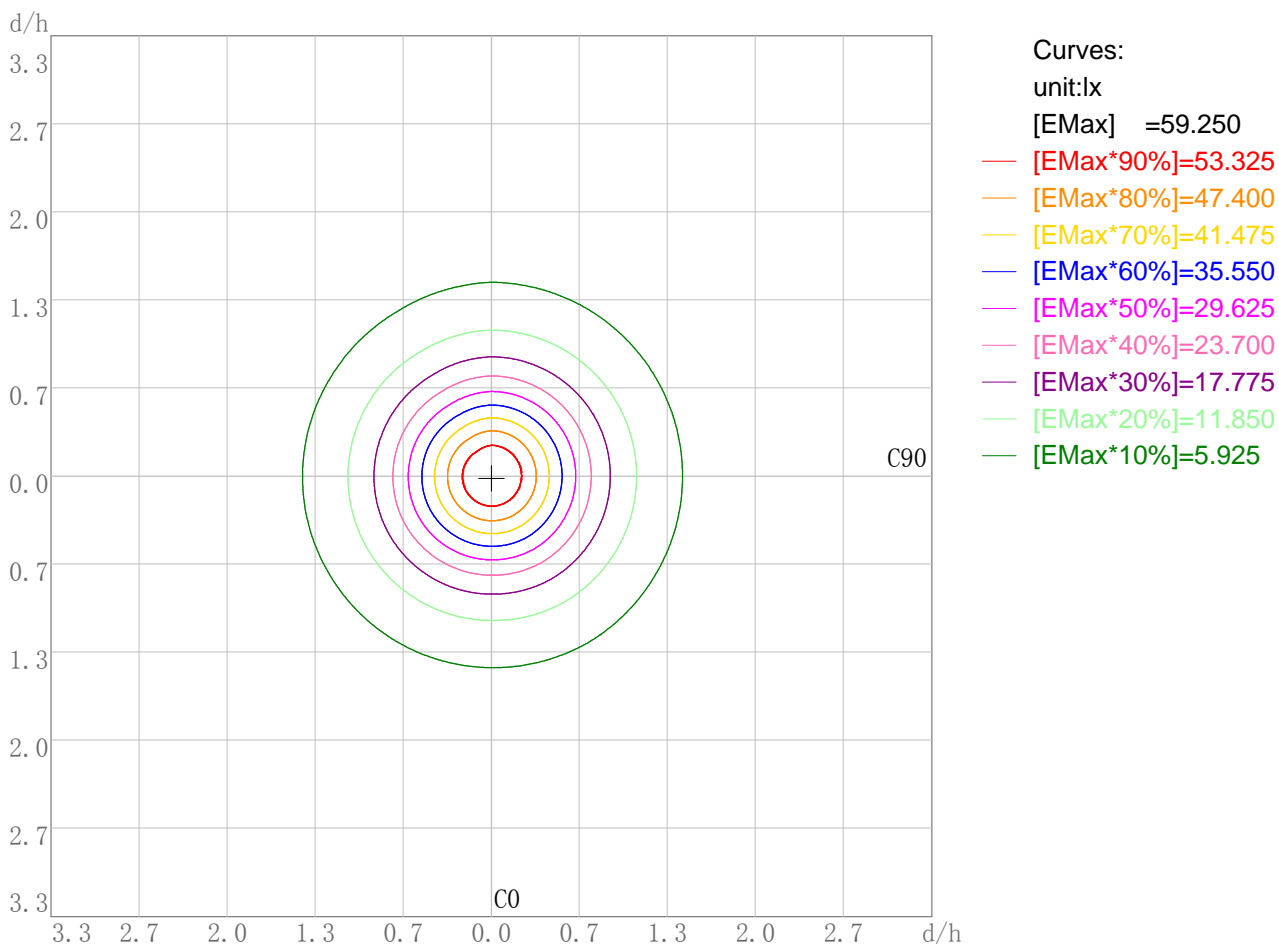

Working Plane Luminaire Mounting Height(m): 3.00
Working Plane Maximum Illuminance(lx): 59.25
Working Plane Maximum Illuminance Position(d/h):H0.0 V0.0

3D Plane ISO Illuminance Diagram

Lum. Name: 20W 4000K	Lum. Catalog:	Test ID: 001
Lamp Name:	Lamp Catalog: LED	Test Lab: Volnic IES
Manufacture:	Test Machine:GON-2000	Test Date: 2019/04/12

3D Plane Illuminance Modal

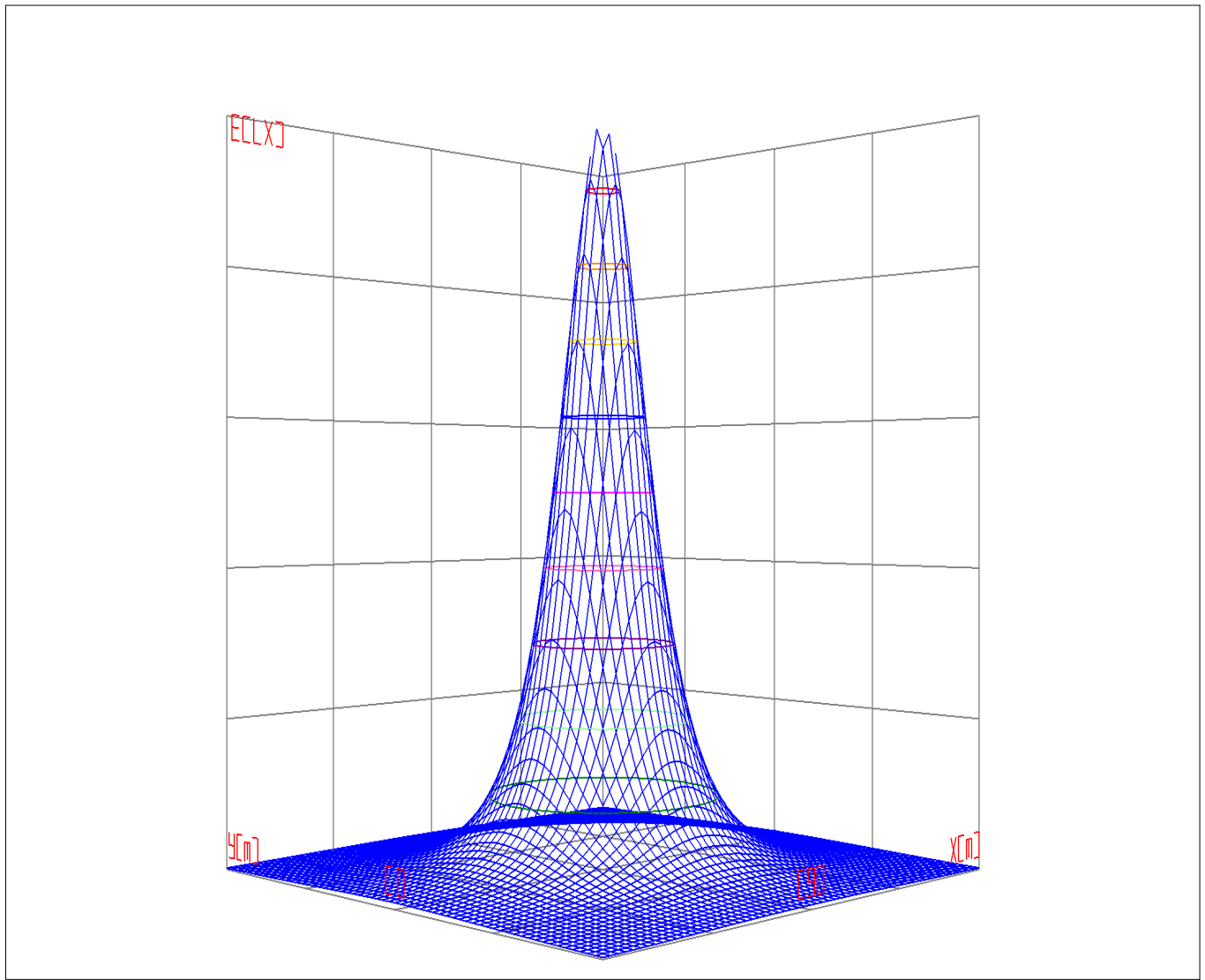

Curves: 3D Model — 90% — 80% — 70% — 60% — 50% — 40% — 30% — 20% — 10% —
View Angles(deg): 0 Height(m): 3.0 Distance(m): 10.0

Space ISO Illuminance Diagram

Lum. Name: 20W 4000K	Lum. Catalog:	Test ID: 001
Lamp Name:	Lamp Catalog: LED	Test Lab: Volnic IES
Manufacture:	Test Machine:GON-2000	Test Date: 2019/04/12

Space ISO Illuminance Curve

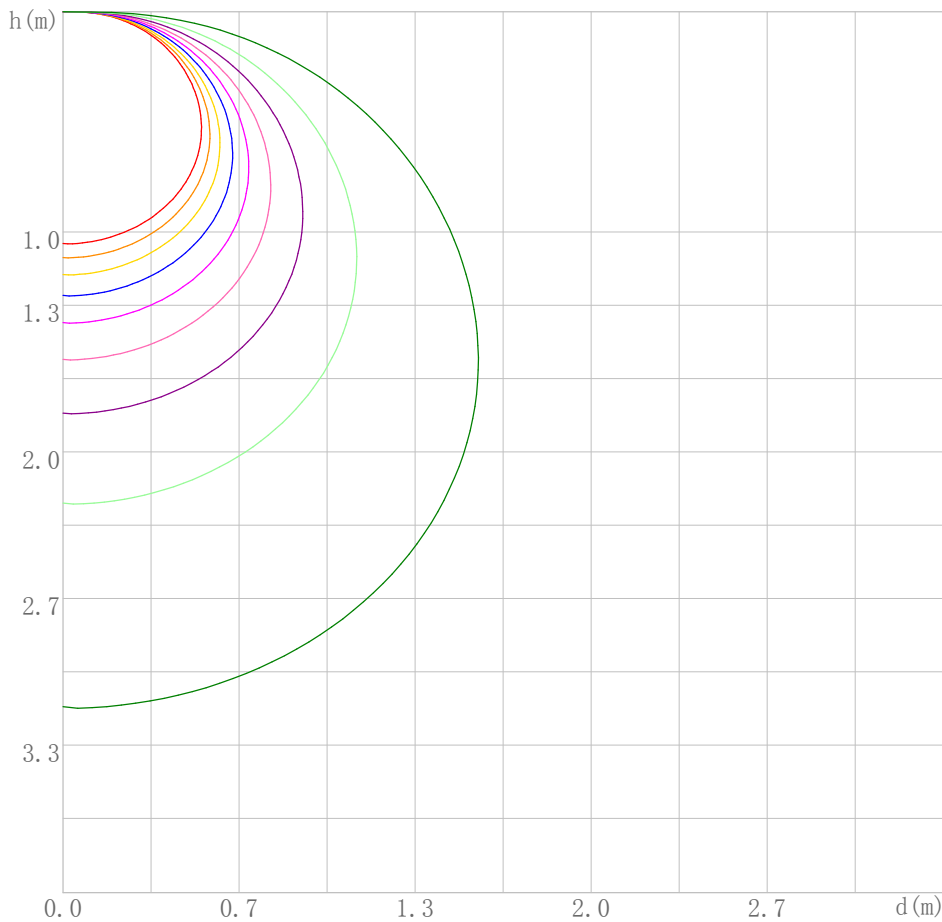

- Curves:
 [Unit: lx]
 [EMax] =533.247
- [EMax*90%]=479.923
 - [EMax*80%]=426.598
 - [EMax*70%]=373.273
 - [EMax*60%]=319.948
 - [EMax*50%]=266.624
 - [EMax*40%]=213.299
 - [EMax*30%]=159.974
 - [EMax*20%]=106.649
 - [EMax*10%]=53.325

Space Plane Maximum Illuminance and @Angle:533.25lx,1.0deg
 Plane Maximum Lighting Intensity and @Angle:533.491cd,0deg

Illuminance-Distance Diagram

Lum. Name: 20W 4000K	Lum. Catalog:	Test ID: 001
Lamp Name:	Lamp Catalog: LED	Test Lab: Volnic IES
Manufacture:	Test Machine:GON-2000	Test Date: 2019/04/12

Illuminance-Distance Curve

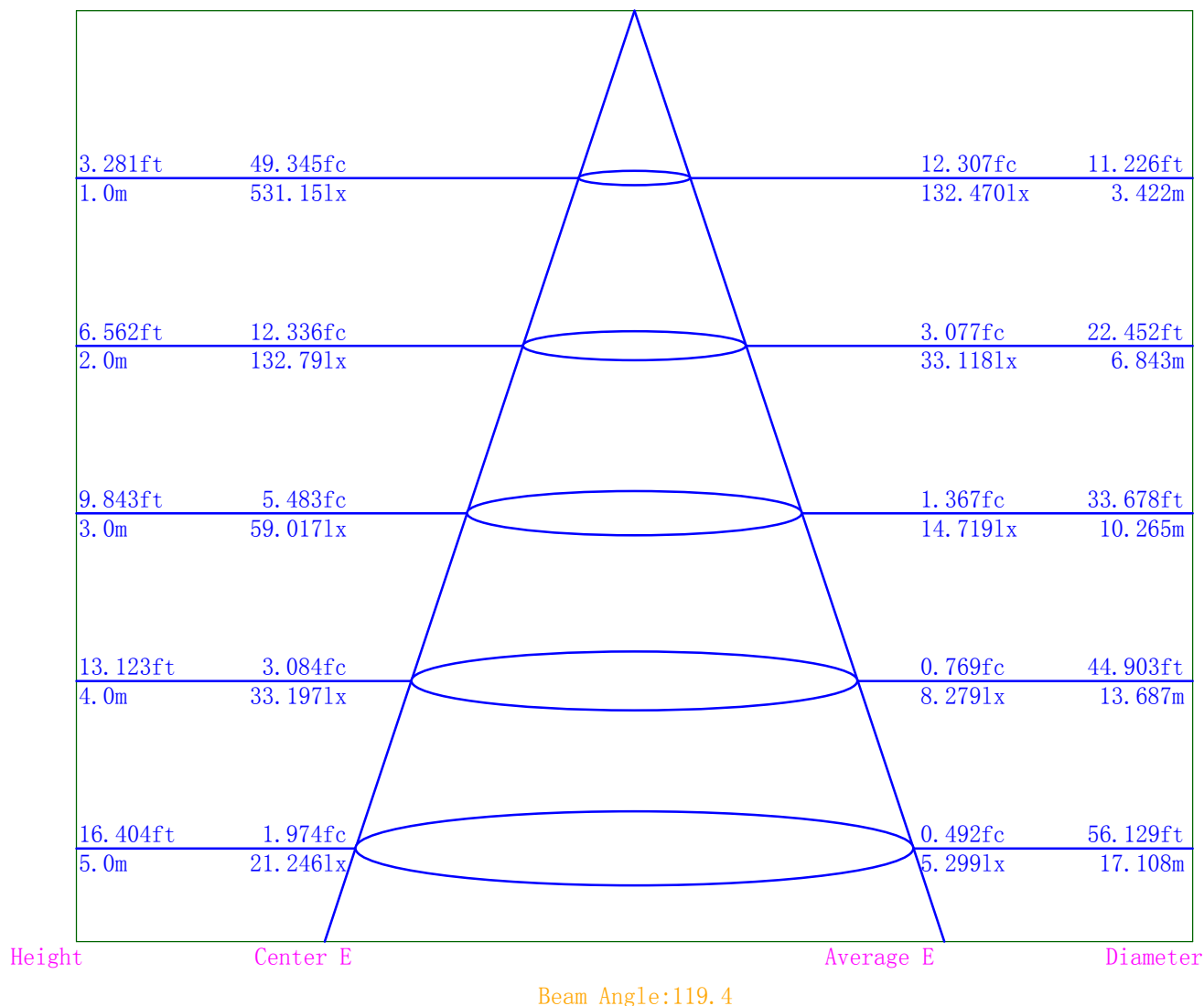

Indoor Luminance Limiting Curves

Lum. Name: 20W 4000K	Lum. Catalog:	Test ID: 001
Lamp Name:	Lamp Catalog: LED	Test Lab: Volnic IES
Manufacture:	Test Machine:GON-2000	Test Date: 2019/04/12

Glare Grade Table

GI	Quality	Using Illuminance							
		a	b	c	d	e	f	g	h
1.15	A	2000	1000	500	<=300				
1.5	B		2000	1000	500	<=300			
1.85	C			2000	1000	500	<=300		
2.2	D				2000	1000	500	<=300	
2.55	E	a				2000	1000	500	<=300
			b	c	d	e	f	g	h

Luminance Table

Gama (deg)	45	50	55	60	65	70	75	80	85
C0	5854	5849	5883	5992	6230	6688	7566	9506	15651
C90	5794	5743	5663	5555	5390	5154	4809	4361	4115

Luminance Limiting Curve

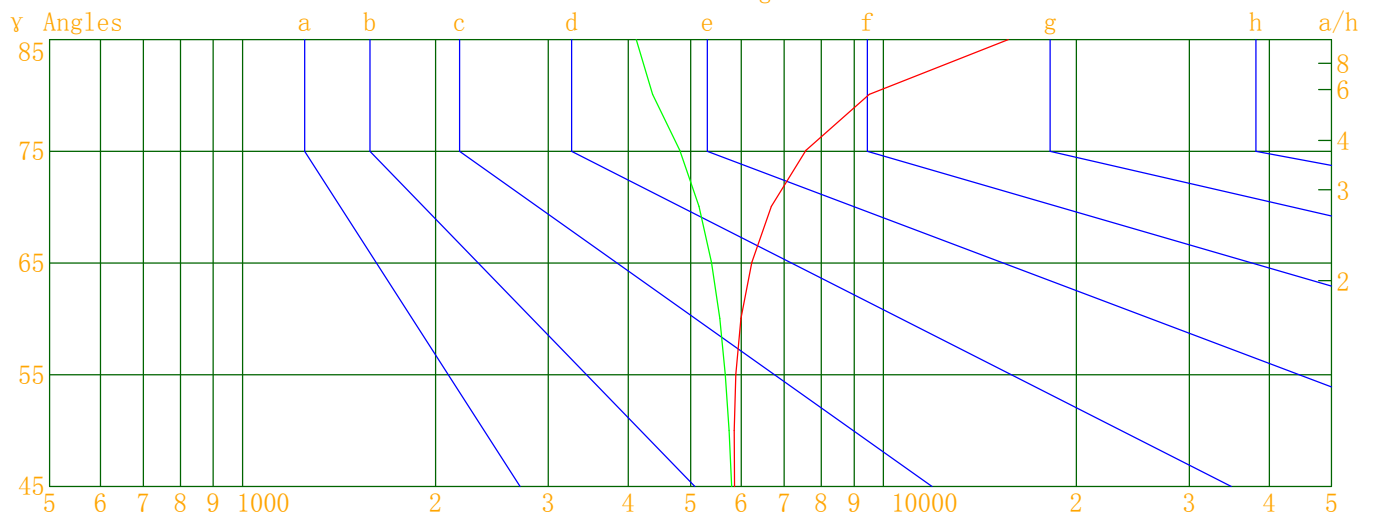

Luminous Size: Length(m)=1.200 Width(m)=0.075 Height(m)=0.000 Area(m²)=0.090000
 Luminous Type: Without Luminous Side
 Luminous Curves: C0-C180 Color: — C90-C270 Color: —

Indoor Budgetary Estimate Table

Lum. Name: 20W 4000K	Lum. Catalog:	Test ID: 001
Lamp Name:	Lamp Catalog: LED	Test Lab: Volnic IES
Manufacture:	Test Machine:GON-2000	Test Date: 2019/04/12

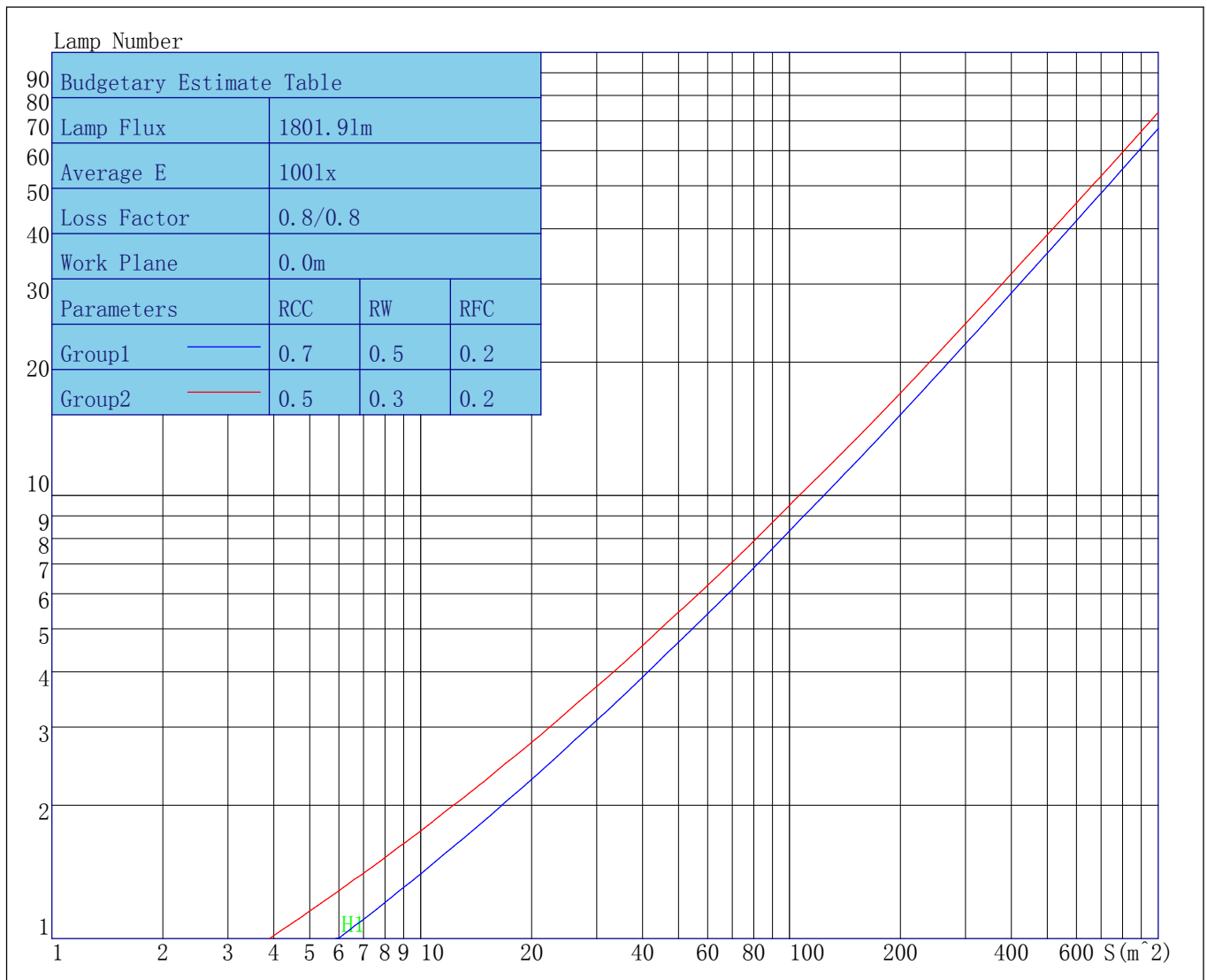

Parameters1: Rhocc = 0.7 Rhow = 0.5 Rhofc = 0.2 LLF = 0.8
Parameters2: Rhocc = 0.5 Rhow = 0.3 Rhofc = 0.2 LLF = 0.8
Average Illuminance(lx): 100 Cavity Height: H1(m) = 2

Indoor Coefficient of Utilization Table

Lum. Name: 20W 4000K	Lum. Catalog:	Test ID: 001
Lamp Name:	Lamp Catalog: LED	Test Lab: Volnic IES
Manufacture:	Test Machine: GON-2000	Test Date: 2019/04/12

Coefficients of Utilization - Zonal Cavity Method																		
Coef.	Effective Floor Cavity Reflectance RFC=0.20																	
RhoCC (%)	80				70				50			30			10			0
RhoW (%)	70	50	30	10	70	50	30	10	50	30	10	50	30	10	50	30	10	0
RCR	Coefficient of Utilization(%)																	
0	117	117	117	117	114	114	114	114	107	107	107	101	101	101	96	96	96	93
1	106	100	95	91	102	97	93	89	92	88	85	86	84	81	82	79	77	75
2	95	86	79	73	92	84	77	71	79	74	69	75	70	66	71	67	64	61
3	87	76	67	60	84	73	65	59	69	63	57	66	60	55	62	57	53	51
4	79	67	57	50	76	65	56	50	61	54	48	58	52	47	55	50	46	43
5	73	59	50	43	70	58	49	43	55	47	42	52	46	40	50	44	39	37
6	67	53	44	38	65	52	43	37	49	42	36	47	40	35	45	39	35	32
7	62	48	39	33	60	47	39	33	45	37	32	43	36	31	41	35	31	28
8	58	44	35	29	56	43	35	29	41	34	28	39	33	28	38	32	27	25
9	54	40	32	26	52	39	31	26	38	31	26	36	30	25	35	29	25	23
10	51	37	29	24	49	36	29	24	35	28	23	34	27	23	32	26	22	20

IES Indoor Report
Photometric Filename:20W 4000K.IES

Unified Glare Rating Table

Lum. Name: 20W 4000K	Lum. Catalog:	Test ID: 001
Lamp Name:	Lamp Catalog: LED	Test Lab: Volnic IES
Manufacture:	Test Machine: GON-2000	Test Date: 2019/04/12

Unified Glare Rating Table

Ceiling RCC	0.70	0.70	0.50	0.50	0.30	0.70	0.70	0.50	0.50	0.30
Wall RW	0.50	0.30	0.50	0.30	0.30	0.50	0.30	0.50	0.30	0.30
Floor RFC	0.20	0.20	0.20	0.20	0.20	0.20	0.20	0.20	0.20	0.20
Room Size	Vewed crosswise					Vewed endwise				
X=2H Y=2H	18.0	19.5	18.5	20.0	20.5	17.8	19.3	18.3	19.8	20.3
Y=3H	20.2	21.6	20.6	22.0	22.5	19.5	20.9	20.0	21.4	21.9
Y=4H	21.3	22.6	21.8	23.1	23.6	20.2	21.6	20.7	22.0	22.6
Y=6H	22.5	23.8	23.0	24.3	24.8	20.8	22.0	21.3	22.5	23.1
Y=8H	23.2	24.4	23.7	24.9	25.4	21.0	22.2	21.5	22.7	23.2
Y=12H	23.9	25.1	24.5	25.6	26.2	21.1	22.3	21.7	22.8	23.4
X=4H Y=2H	18.8	20.1	19.3	20.6	21.1	18.7	20.0	19.2	20.5	21.0
Y=3H	21.1	22.3	21.7	22.8	23.4	20.6	21.7	21.1	22.2	22.8
Y=4H	22.4	23.5	23.0	24.0	24.6	21.4	22.5	22.0	23.0	23.6
Y=6H	23.9	24.8	24.4	25.3	25.9	22.2	23.1	22.7	23.6	24.2
Y=8H	24.6	25.5	25.2	26.0	26.7	22.4	23.3	23.0	23.9	24.5
Y=12H	25.5	26.3	26.1	26.9	27.5	22.7	23.4	23.2	24.0	24.7
X=8H Y=4H	22.8	23.7	23.4	24.3	24.9	22.0	22.9	22.6	23.4	24.1
Y=6H	24.5	25.2	25.1	25.8	26.6	23.0	23.7	23.6	24.3	25.1
Y=8H	25.4	26.1	26.0	26.7	27.3	23.4	24.1	24.0	24.7	25.3
Y=12H	26.5	27.1	27.2	27.7	28.4	23.8	24.4	24.4	25.0	25.7
X=12H Y=4H	22.9	23.7	23.5	24.3	24.9	22.2	23.0	22.8	23.5	24.2
Y=6H	24.6	25.3	25.2	25.8	26.5	23.3	23.9	23.9	24.5	25.2
Y=8H	25.7	26.2	26.3	26.8	27.5	23.8	24.4	24.4	25.0	25.7
Variations with the objverver position at spacings										
S=1.0H	0.1/-0.1					0.4/-0.4				
S=1.5H	0.2/-0.2					0.6/-0.7				
S=2.0H	0.1/-0.2					0.7/-0.9				
Reduced UGR Table:										
Nordic Standard Table:	BKO					BKO				
Correction Value	4.8					3.6				

o the CIE Pub. 117, data has been corrected, refers to the lamp's lumens 8.2flm.

IES Indoor Report

Photometric Filename: 20W 4000K.IES

Candela Tabulation

V/H	C0.0	C30.0	C60.0	C90.0	C120.0	C150.0	C180.0	C210.0	C240.0	C270.0	C300.0	C330.0
Y 0.0	531.15	531.15	531.15	531.15	531.15	531.15	531.15	531.15	531.15	531.15	531.15	531.15
Y 1.0	533.49	531.69	530.72	530.09	529.62	529.37	533.10	531.41	530.58	529.86	529.36	529.16
Y 2.0	533.23	531.51	530.67	529.98	529.43	529.20	532.86	531.07	530.26	529.51	528.96	528.71
Y 3.0	532.92	531.22	530.31	529.67	529.05	528.94	532.24	530.49	529.67	529.05	528.49	528.13
Y 4.0	532.44	530.78	529.84	529.23	528.71	528.49	531.48	529.78	528.90	528.18	527.75	527.41
Y 5.0	531.78	530.16	529.19	528.53	527.97	527.86	530.54	528.84	528.11	527.34	526.81	526.43
Y 6.0	531.05	529.33	528.31	527.77	527.21	527.15	529.49	527.69	526.91	526.16	525.69	525.35
Y 7.0	530.04	528.27	527.28	526.67	526.19	526.12	528.21	526.58	525.81	524.97	524.51	524.15
Y 8.0	528.85	527.05	526.05	525.52	524.93	524.96	526.78	525.22	524.41	523.64	523.11	522.81
Y 9.0	527.43	525.78	524.69	524.22	523.62	523.64	525.24	523.68	522.89	522.06	521.49	521.16
Y 10.0	525.90	524.28	523.25	522.69	522.10	522.22	523.41	521.87	521.18	520.27	519.74	519.31
Y 11.0	524.27	522.59	521.51	521.05	520.49	520.57	521.63	519.96	519.16	518.37	517.85	517.37
Y 12.0	522.35	520.89	519.61	519.03	518.52	518.71	519.42	517.91	517.19	516.21	515.69	515.24
Y 13.0	520.36	518.79	517.64	517.03	516.56	516.71	517.20	515.76	514.94	514.03	513.43	512.97
Y 14.0	518.13	516.48	515.37	514.93	514.32	514.56	514.90	513.30	512.57	511.65	511.07	510.57
Y 15.0	515.70	514.09	513.06	512.56	511.99	512.24	512.24	510.70	509.93	509.00	508.49	507.93
Y 16.0	513.28	511.56	510.64	510.04	509.43	509.73	509.46	507.90	507.27	506.26	505.80	505.07
Y 17.0	510.52	508.89	507.87	507.29	506.79	507.11	506.57	505.06	504.35	503.39	502.82	502.15
Y 18.0	507.67	506.08	505.13	504.52	503.95	504.24	503.47	502.07	501.19	500.31	499.74	498.91
Y 19.0	504.65	503.09	501.97	501.50	501.01	501.35	500.28	498.72	498.06	497.15	496.46	495.80
Y 20.0	501.39	499.91	498.82	498.36	497.82	498.15	496.86	495.25	494.79	493.67	493.05	492.38
Y 21.0	498.12	496.48	495.44	494.90	494.44	494.81	493.32	491.73	491.18	490.13	489.52	488.77
Y 22.0	494.49	492.94	491.95	491.46	490.91	491.28	489.62	488.12	487.48	486.42	485.76	484.98
Y 23.0	490.77	489.24	488.25	487.81	487.20	487.73	485.61	484.07	483.62	482.53	481.83	481.06
Y 24.0	486.95	485.40	484.54	483.98	483.37	483.87	481.59	480.06	479.63	478.50	477.76	477.05
Y 25.0	482.92	481.36	480.57	480.09	479.44	479.89	477.36	476.02	475.49	474.40	473.56	472.83
Y 26.0	478.75	477.27	476.28	475.93	475.35	475.71	472.95	471.70	471.28	470.05	469.24	468.44
Y 27.0	474.43	472.90	472.02	471.55	471.07	471.39	468.35	467.08	466.74	465.48	464.72	463.83
Y 28.0	469.96	468.43	467.55	467.05	466.56	466.88	463.81	462.40	462.12	460.80	460.02	459.14
Y 29.0	465.32	463.78	463.01	462.38	462.00	462.27	458.86	457.53	457.30	456.06	455.19	454.31
Y 30.0	460.48	459.10	458.23	457.63	457.23	457.61	453.97	452.69	452.35	451.09	450.23	449.32
Y 31.0	455.66	454.20	453.35	452.78	452.34	452.73	448.86	447.51	447.35	446.04	445.20	444.20
Y 32.0	450.40	449.21	448.24	447.70	447.30	447.59	443.63	442.42	442.01	440.85	439.93	438.97
Y 33.0	445.12	443.93	443.02	442.45	441.94	442.34	438.28	437.02	436.58	435.50	434.56	433.52
Y 34.0	439.79	438.47	437.64	437.08	436.65	437.00	432.59	431.56	431.16	429.89	428.95	427.95
Y 35.0	434.29	432.98	432.12	431.64	431.18	431.52	426.93	425.87	425.39	424.27	423.25	422.35
Y 36.0	428.70	427.38	426.45	425.96	425.64	425.92	421.14	420.03	419.61	418.50	417.50	416.48
Y 37.0	423.03	421.61	420.76	420.14	419.77	420.12	415.12	414.15	413.76	412.58	411.46	410.62
Y 38.0	417.03	415.76	414.89	414.21	413.84	414.38	409.09	407.99	407.65	406.46	405.26	404.50
Y 39.0	410.99	409.68	408.66	407.98	407.71	408.27	402.90	401.83	401.40	400.17	399.08	398.38
Y 40.0	404.78	403.37	402.43	401.82	401.50	402.08	396.59	395.46	395.04	393.89	392.67	391.91
Y 41.0	398.71	397.04	396.15	395.44	395.13	395.73	390.17	389.02	388.56	387.33	386.08	385.38
Y 42.0	392.27	390.68	389.74	388.99	388.79	389.42	383.51	382.44	381.89	380.75	379.40	378.77
Y 43.0	385.72	384.19	383.16	382.37	382.13	382.87	376.90	375.92	375.20	373.98	372.65	372.15
Y 44.0	379.14	377.56	376.21	375.69	375.37	376.14	370.22	369.17	368.31	367.12	365.91	365.48
Y 45.0	372.57	370.72	369.38	368.70	368.48	369.35	363.48	362.27	361.41	360.14	358.87	358.69
Y 46.0	365.80	363.87	362.33	361.56	361.39	362.43	356.54	355.25	354.15	352.96	351.69	351.64

IES Indoor Report

Photometric Filename: 20W 4000K.IES

Candela Tabulation - (Cont.)

V/H	C0.0	C30.0	C60.0	C90.0	C120.0	C150.0	C180.0	C210.0	C240.0	C270.0	C300.0	C330.0
Y 47.0	359.00	356.95	355.30	354.29	354.35	355.55	349.70	348.28	346.86	345.60	344.25	344.58
Y 48.0	352.23	350.01	347.98	346.95	347.14	348.64	342.63	341.11	339.59	338.25	336.96	337.41
Y 49.0	345.38	342.88	340.72	339.62	339.80	341.44	335.78	334.03	332.06	330.77	329.48	330.36
Y 50.0	338.38	335.72	333.31	332.22	332.33	334.33	328.80	326.84	324.65	323.32	322.04	323.21
Y 51.0	331.38	328.44	325.53	324.39	324.65	327.02	321.80	319.53	316.97	315.43	314.30	315.86
Y 52.0	324.47	321.14	317.88	316.50	316.99	319.76	314.68	312.09	309.25	307.42	306.41	308.53
Y 53.0	317.57	313.81	310.07	308.51	309.26	312.38	307.69	304.74	301.34	299.55	298.48	301.23
Y 54.0	310.60	306.57	302.37	300.44	301.33	305.17	300.65	297.45	293.30	291.59	290.45	293.87
Y 55.0	303.71	299.21	294.34	292.36	293.31	297.83	293.70	290.20	285.37	283.35	282.50	286.63
Y 56.0	296.82	292.03	286.24	284.09	285.15	290.56	286.87	282.86	277.26	275.22	274.34	279.14
Y 57.0	289.88	284.48	278.00	275.71	277.10	283.21	280.07	275.71	269.01	266.67	266.09	271.84
Y 58.0	283.01	277.17	269.82	267.24	268.79	275.96	273.17	268.30	260.74	258.24	257.77	264.43
Y 59.0	276.37	269.92	261.57	258.61	260.55	268.69	266.34	261.11	252.37	249.47	249.43	257.17
Y 60.0	269.66	262.75	253.37	249.95	252.28	261.59	259.66	253.95	244.07	240.99	241.08	250.14
Y 61.0	263.11	255.57	245.00	241.32	243.99	254.48	253.04	246.99	235.76	232.23	232.74	243.15
Y 62.0	256.40	248.53	236.58	232.46	235.54	247.43	246.41	240.06	227.34	223.28	224.29	236.14
Y 63.0	249.87	241.46	228.09	223.35	227.03	240.49	239.93	232.97	219.00	214.21	215.86	229.08
Y 64.0	243.45	234.49	219.68	214.24	218.67	233.56	233.39	226.02	210.49	205.20	207.31	222.18
Y 65.0	236.95	227.54	211.32	205.01	210.42	226.54	226.86	219.22	202.08	196.10	198.84	215.40
Y 66.0	230.70	220.82	203.08	195.93	202.00	219.83	220.53	212.55	193.72	186.94	190.45	208.67
Y 67.0	224.42	213.99	194.72	186.79	193.74	213.14	214.25	205.94	185.54	177.85	182.13	202.03
Y 68.0	218.16	207.33	186.41	177.47	185.46	206.53	208.19	199.44	177.45	168.68	174.00	195.52
Y 69.0	211.91	200.68	178.16	168.07	177.35	199.94	202.01	192.89	169.39	159.36	165.84	188.95
Y 70.0	205.86	194.15	170.03	158.65	169.32	193.41	195.80	186.36	161.37	149.92	157.61	182.57
Y 71.0	199.88	187.78	162.16	149.33	161.46	187.04	189.84	180.05	153.49	140.65	149.72	176.28
Y 72.0	193.87	181.45	154.49	139.96	153.87	180.77	183.80	173.97	145.83	131.38	142.01	170.00
Y 73.0	187.99	175.23	146.87	130.58	146.26	174.57	178.00	167.98	138.40	122.21	134.47	163.87
Y 74.0	182.08	169.04	139.49	121.42	138.81	168.48	172.28	161.79	131.18	113.08	127.05	157.96
Y 75.0	176.23	162.92	132.16	112.03	131.43	162.47	166.57	155.88	124.01	103.68	119.84	151.96
Y 76.0	170.51	156.98	125.14	102.81	124.58	156.56	160.89	150.06	117.08	94.58	112.72	146.02
Y 77.0	165.04	151.10	118.18	93.90	117.84	150.73	155.26	144.35	110.25	85.64	105.76	140.24
Y 78.0	159.44	145.30	111.54	85.10	111.11	144.95	149.77	138.63	103.69	76.99	99.17	134.73
Y 79.0	153.94	139.71	104.84	76.44	104.63	139.42	144.34	133.24	97.31	68.56	92.81	129.30
Y 80.0	148.57	134.07	98.73	68.16	98.35	133.97	139.01	127.91	91.26	60.41	86.68	123.84
Y 81.0	143.24	128.54	92.58	60.10	92.39	128.45	133.85	122.45	85.31	52.47	80.71	118.63
Y 82.0	137.92	123.18	86.74	52.28	86.58	123.02	128.65	117.18	79.55	44.97	74.94	113.25
Y 83.0	132.92	117.91	81.11	45.03	81.02	117.79	123.53	112.01	73.98	37.83	69.50	108.12
Y 84.0	127.80	112.78	75.82	38.39	75.81	112.61	118.50	106.84	68.79	31.28	64.22	103.09
Y 85.0	122.77	107.59	70.63	32.28	70.61	107.59	113.44	101.87	63.72	25.46	59.36	98.16
Y 86.0	117.83	102.65	65.59	27.08	65.71	102.69	108.63	97.09	59.00	20.51	54.68	93.37
Y 87.0	112.87	97.66	60.88	22.44	61.06	97.73	103.85	92.38	54.37	16.33	50.18	88.68
Y 88.0	108.06	93.03	56.35	18.86	56.54	93.12	99.30	87.68	49.98	13.32	45.86	84.07
Y 89.0	103.38	88.35	52.26	16.50	52.50	88.57	94.67	83.26	45.88	11.42	41.81	79.62
Y 90.0	98.82	83.80	48.22	15.13	48.47	84.09	90.17	78.86	41.96	10.30	37.98	75.25
Y 91.0	94.43	79.54	44.43	14.80	44.81	79.70	85.86	74.65	38.26	10.13	34.46	71.10
Y 92.0	89.95	75.26	40.72	14.63	41.18	75.62	81.57	70.48	34.87	10.06	31.18	67.00
Y 93.0	85.64	71.06	37.43	14.49	37.90	71.51	77.46	66.46	31.60	9.91	28.13	63.01

IES Indoor Report
Photometric Filename:20W 4000K.IES

Candela Tabulation - (Cont.)

V/H	C0.0	C30.0	C60.0	C90.0	C120.0	C150.0	C180.0	C210.0	C240.0	C270.0	C300.0	C330.0
Y 94.0	81.47	67.04	34.34	14.41	34.83	67.43	73.42	62.61	28.64	9.85	25.26	59.15
Y 95.0	77.49	63.17	31.57	14.25	32.03	63.61	69.34	58.80	25.77	9.74	22.68	55.39
Y 96.0	73.46	59.44	29.06	14.22	29.58	59.96	65.46	55.00	23.42	9.66	20.47	51.87
Y 97.0	69.63	55.76	26.84	14.03	27.34	56.27	61.82	51.56	21.47	9.59	18.50	48.44
Y 98.0	65.88	52.31	24.81	13.87	25.33	52.96	58.15	48.21	19.51	9.56	16.75	45.24
Y 99.0	62.14	48.90	22.95	13.77	23.49	49.56	54.68	44.96	17.83	9.47	15.27	42.09
Y 100.0	58.63	45.71	21.47	13.67	21.91	46.38	51.27	41.98	16.27	9.44	13.96	39.17
Y 101.0	55.31	42.68	20.07	13.65	20.56	43.38	48.05	39.06	15.01	9.45	12.97	36.43
Y 102.0	52.09	39.88	18.83	13.50	19.29	40.57	44.99	36.47	13.81	9.32	11.95	33.78
Y 103.0	48.92	37.28	17.69	13.40	18.17	38.11	42.05	33.90	12.82	9.37	11.18	31.38
Y 104.0	45.98	34.81	16.81	13.24	17.19	35.63	39.24	31.56	12.00	9.35	10.52	29.16
Y 105.0	43.21	32.35	16.00	13.13	16.44	33.15	36.67	28.98	11.29	9.27	10.03	26.24
Y 106.0	40.60	29.77	15.33	13.04	15.75	30.32	34.28	26.58	10.74	9.29	9.56	23.87
Y 107.0	37.97	27.67	14.80	12.98	15.12	28.02	31.36	24.49	10.16	9.32	9.09	22.04
Y 108.0	34.98	25.66	14.44	12.86	14.70	26.02	28.89	22.79	9.79	9.27	9.00	20.50
Y 109.0	32.77	24.08	14.03	12.78	14.33	24.63	26.89	21.33	9.56	9.21	8.88	19.11
Y 110.0	30.78	22.74	13.74	12.66	13.99	23.23	25.04	19.95	9.22	9.18	8.69	17.66
Y 111.0	28.91	21.31	13.52	12.63	13.70	21.90	23.33	18.55	9.06	9.25	8.74	16.41
Y 112.0	27.11	19.96	13.52	12.44	13.46	20.53	21.72	17.30	8.95	9.09	8.82	15.35
Y 113.0	25.51	18.85	13.42	12.43	13.34	19.32	20.30	16.19	8.82	9.25	8.81	14.31
Y 114.0	23.87	17.68	13.30	12.44	13.24	18.28	18.93	15.20	8.80	9.24	8.81	13.43
Y 115.0	22.48	16.71	13.16	12.26	13.09	17.36	17.62	14.32	8.86	9.38	8.92	12.70
Y 116.0	21.20	15.91	13.15	12.27	13.01	16.49	16.46	13.66	8.83	9.38	8.94	12.03
Y 117.0	20.00	15.14	13.06	12.13	12.92	15.93	15.36	13.00	8.88	9.48	9.01	11.57
Y 118.0	18.91	14.57	12.89	12.08	12.84	15.21	14.45	12.45	8.98	9.44	8.94	11.14
Y 119.0	17.89	14.04	12.81	12.06	12.77	14.61	13.61	11.90	9.09	9.57	9.02	10.72
Y 120.0	16.97	13.61	12.82	12.08	12.78	14.20	12.85	11.50	9.02	9.63	9.10	10.38
Y 121.0	16.17	13.14	12.75	12.01	12.66	13.80	12.28	11.16	9.10	9.57	9.09	10.23
Y 122.0	15.54	12.91	12.65	12.01	12.59	13.42	11.78	10.77	9.11	9.55	9.11	9.98
Y 123.0	14.93	12.68	12.58	11.99	12.44	13.07	11.27	10.59	9.19	9.49	9.11	9.88
Y 124.0	14.46	12.46	12.53	11.85	12.44	12.75	10.88	10.39	9.19	9.46	9.21	9.82
Y 125.0	14.03	12.45	12.39	11.86	12.40	12.52	10.56	10.13	9.28	9.57	9.19	9.90
Y 126.0	13.79	12.40	12.39	11.80	12.43	12.35	10.28	10.09	9.26	9.50	9.28	9.88
Y 127.0	13.50	12.29	12.34	11.78	12.43	12.27	9.89	10.05	9.36	9.51	9.37	9.92
Y 128.0	13.30	12.27	12.30	11.77	12.30	12.22	9.81	10.09	9.42	9.56	9.40	10.00
Y 129.0	13.19	12.27	12.24	11.71	12.34	12.21	9.66	10.18	9.52	9.66	9.46	10.00
Y 130.0	13.11	12.23	12.21	11.69	12.19	12.19	9.69	10.24	9.46	9.80	9.52	10.09
Y 131.0	13.06	12.12	12.18	11.70	12.19	12.23	9.69	10.20	9.62	9.73	9.58	10.11
Y 132.0	12.97	12.19	12.13	11.65	12.12	12.27	9.67	10.27	9.59	9.84	9.60	10.13
Y 133.0	12.81	12.20	12.14	11.68	12.15	12.22	9.75	10.24	9.72	9.93	9.70	10.11
Y 134.0	12.89	11.97	12.05	11.62	12.11	12.20	9.78	10.34	9.89	9.98	9.75	10.19
Y 135.0	12.85	12.06	12.05	11.59	12.06	12.12	9.83	10.37	9.96	10.04	9.68	10.19
Y 136.0	12.76	12.08	12.04	11.58	12.01	12.12	9.75	10.33	9.92	10.15	9.76	10.20
Y 137.0	12.80	12.09	12.00	11.64	12.03	12.03	9.91	10.39	10.09	10.12	9.93	10.39
Y 138.0	12.78	12.03	12.08	11.69	12.01	12.09	9.94	10.53	10.07	10.22	10.10	10.41
Y 139.0	12.70	11.96	12.07	11.67	12.07	12.13	10.00	10.46	10.12	10.17	10.16	10.43
Y 140.0	12.68	11.95	12.07	11.74	12.05	12.19	10.06	10.57	10.25	10.36	10.13	10.55

